



Description

Registre GBL mise en place pour réglage fluide de la pression d'air dans la gaine de ventilation. Grâce à la fermeture à Iris l'étranglement ne provoque pas des turbulences et des bruits dans la gaine.

Exemple de désignation

Code produit : GBL - aaa

Type _____
 $\varnothing d_1$ _____

Dimensions

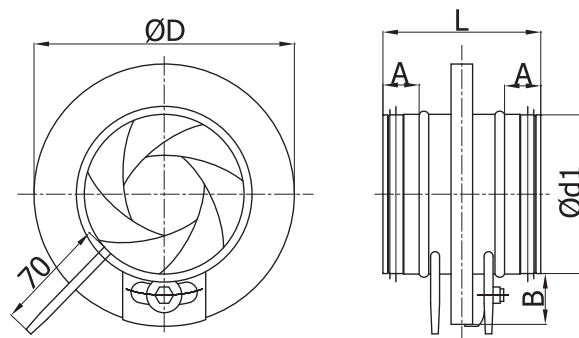

$\varnothing d_1$ nom [mm]	$\varnothing D$ [mm]	L [mm]	A [mm]	B [mm]	pois [kg]
80	125	110	30	22	0,5
100	165	110	30	32	0,5
125	188	110	30	32	0,7
150	230	210	40	40	1,3
160	230	110	30	35	0,9
200	285	110	30	42	1,4
250	335	135	40	42	2,1
315	410	135	40	47	3,5
400	525	190	60	62	6,4
500	655	170	50	77	9,6
630	815	170	50	92	15,6
800	1015	270	100	107	25,0

Spécifications

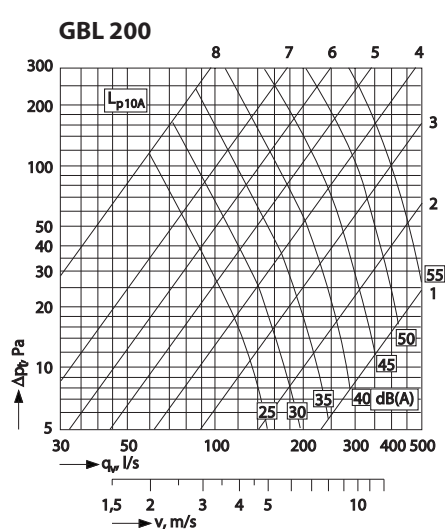
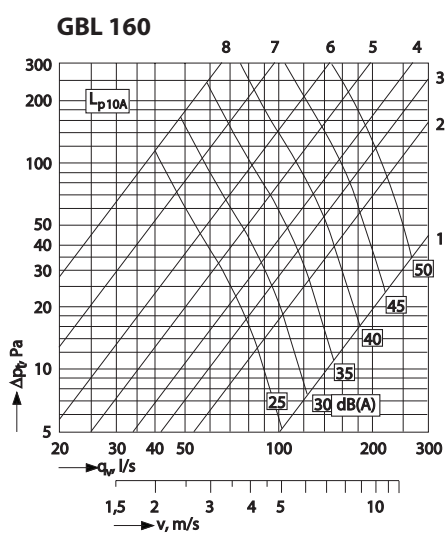
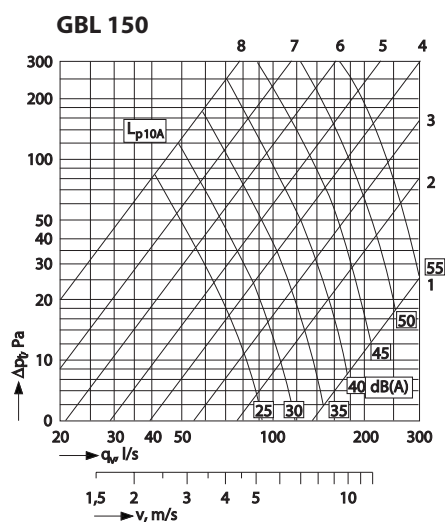
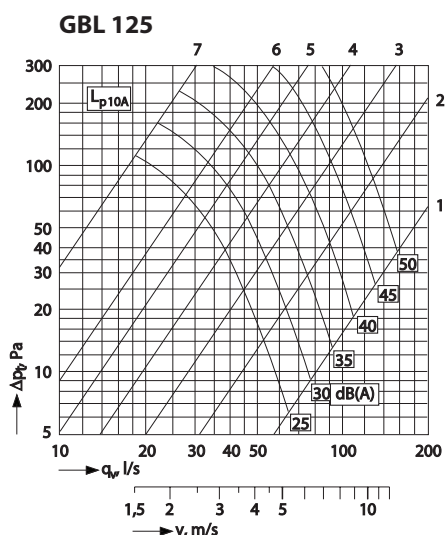
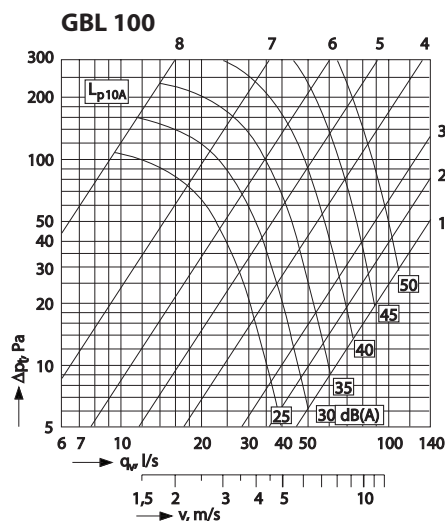
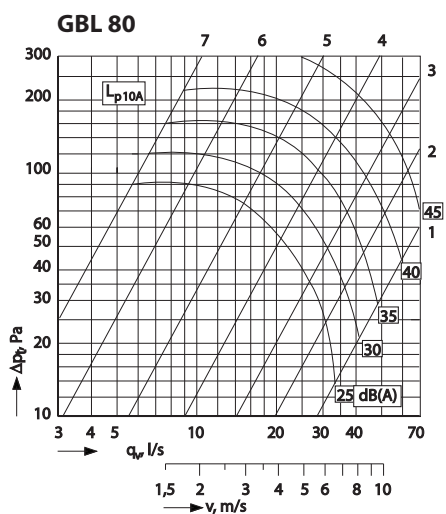

Spécifications

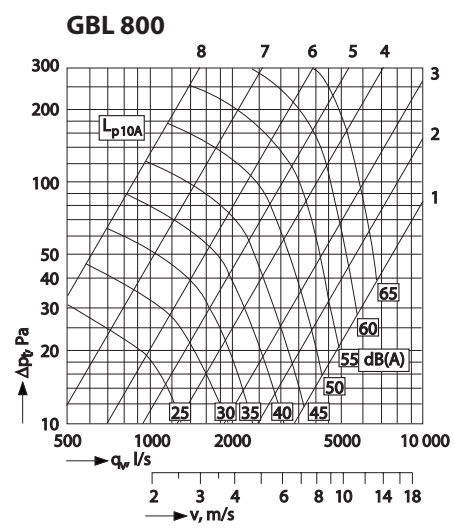
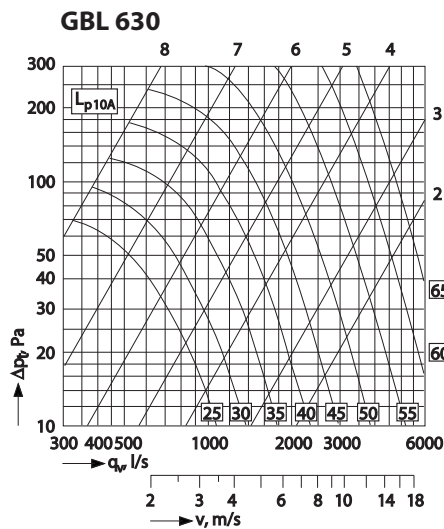
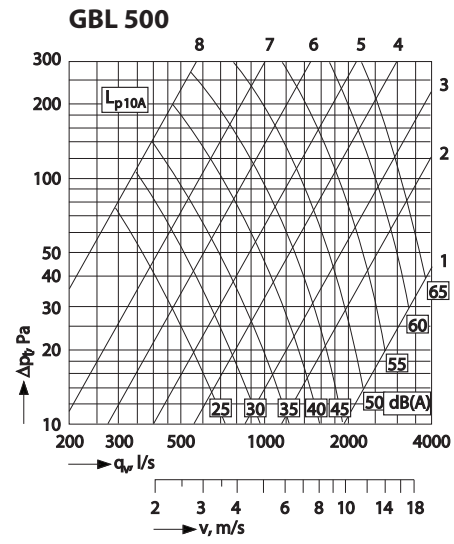
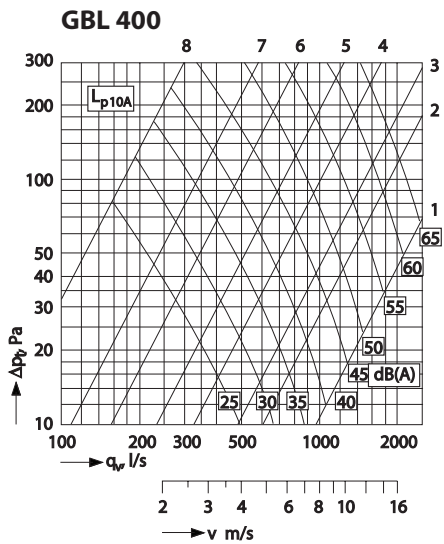
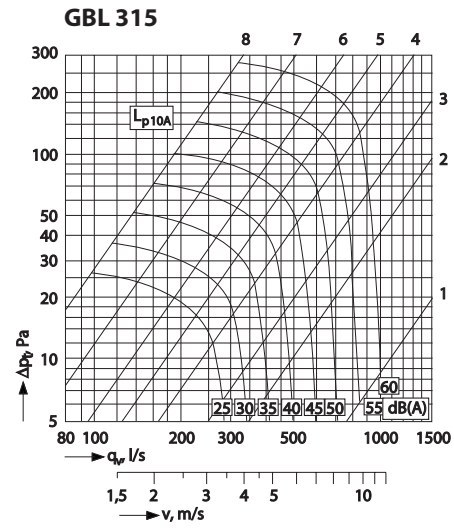
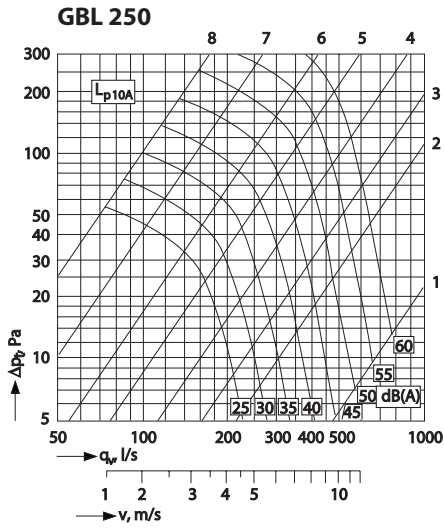

Pt (Pa) - perte de pression
LA (dB (A)) - Niveau de pression sonore
 q_v (L / s) - débit volumétrique
V (m / s) - débit